

## Content

What is 'Optical Radiation'?	14.02
Definition of Photometric and Radiometric Meas. Variables	14.02
Comparison of Photometric and Radiometric Measurable Variables	14.03
Spectral Valuation Function	14.03
Determination of Photometric Characteristic Factors	14.04
Radiation probe FLA 623 x	14.05
Probe for measuring illuminance FLA 623 VL	14.05
Probe for UVA radiation FLA 623 UVA	14.06
Probe for UVB radiation FLA 623 UVB	14.06
Probe for UVC radiation FLA 623 UVC	14.06
Probe for global radiation FLA 623 GS	14.07
Probe for infra-red radiation FLA 623 IR	14.07
Probe for quantum radiation FLA 623 PS	14.07
Lux probe head for illuminance FLA 613 VLK	14.08
UVA probe head spherical characteristic FLA 613U VAK	14.08
V- lambda radiation sensor FLAD 03 VL1	14.09
Digital sensor for color temperature and illuminance	14.10
Luminance Probe Head FLA 603 LDM2	14.12
Light Flux Probe Head FLA 603 LSM4	14.12

---

Probe Heads for Outdoor Operation see Chapter Meteorology

# Optical radiation

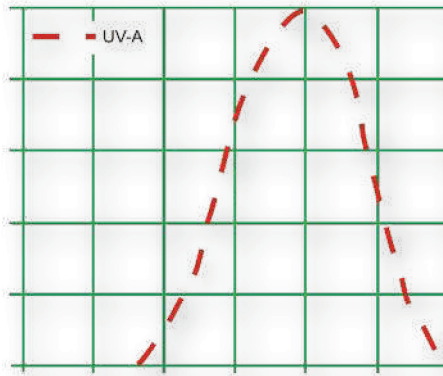

## What is 'Optical Radiation'?

Optical radiation covers the wave length range from 100nm to 1mm of the electromagnetic radiation spectrum.

It must be considered that, with regard to the range limits, they do not present a sharp separation, which is compulsory for all applications.

The detection of optical radiation can, for example, be measured by means of radiometric, photometric, photobiological or plant-physiological measurable variables.

100 nm	200 nm	400 nm	600 nm	800 nm	1000 nm	1200 nm	1400 nm	1600 nm	1800 nm	3,0 μm	1 mm			
UV: ultraviolet radiation			VIS: visible radiation, light				IR: infrared radiation							
UV-C 100 - 280 nm		UV-B 280 - 315 nm	UV-A 315 - 400 nm	violet	blue	bluish green	green	yellowish green	yellow	orange	red	IR-A 800 - 1400 nm	IR-B 1400 nm - 3,0 μm	IR-C 3,0 μm - 1 mm

## Definition of Photometric and Radiometric Measurable Variables

### Photometry

Limited to the range of the optical spectrum (light) that is visible to the human eye. Photometric measurable variables include: Light flux, illuminance, luminance and luminous intensity. The main characteristics of photometry is the evaluation of the brightness perception by the spectral luminosity function of the eye for photopic vision or, in rare cases, for scotopic vision (DIN 5031). Radiation detectors for photometric measuring tasks must, therefore, provide one of these spectral response characteristics.

### Light Flux

The luminous power of a light source (lamp, LED etc.). As lamps do not generally emit a completely parallel luminous beam, the light flux measurement is performed by using measurement geometries, which

detect the light flux independent from its geometric distribution. In most cases Ulbricht globe photometers or goniometers will be used.

### Luminous Intensity

The part of a light flux, which radiates in one specific direction. The luminous intensity is an important variable for calculating the efficiency and quality of lighting equipment. The measurement is performed by detectors with a defined field of view and placed at distances that allow to consider the light source as a point light source.

### Luminance

The brightness sensation provided by an illuminated or luminous surface to the eye. In many cases the luminance data will provide significantly better information regarding the quality of a light than the

illuminance. For measuring the luminance, measuring heads with a defined measuring field angle are used.

### Illuminance

The light flux of one or several light sources striking a certain surface horizontally or vertically. In case of a non-parallel incidence (which is the typical case in practical photometry) a cosine diffusor must be used as measurement geometries.

### Radiometry

Metrological evaluation of optical radiation using the radiometric variables „Radiation Capacity“, „Radiant Intensity“, „Radiancy“ and „Intensity of Irradiation“. The main characteristic of radiometry is the wavelength-independent examination of the intensity of radiation. This is the significant difference between radiometry and actively weighted

# Optical radiation

measurable variables, such as variables used in photometry, photobiology, plant physiology etc.

## Radiation Capacity

The overall power provided by radiation.

## Radiant Intensity

The quotient from the radiation capacity emitted by the light source into a certain direction and the solid angle being covered. The radiant intensity is used for the measurement of the geometric distribution of the radiation capacity.

## Radiancy

The quotient from the radiation capacity passing through (striking) a plane in a certain direction and the product of the passed solid angle and the projection of the plane to a plane surface, which is perpendicular to the examined direction. The radiancy is used for the evaluation of aperture radiators. Steradian or telescopic geometries.

## Intensity of Irradiation



The quotient of the radiation capacity striking a plane and the illuminated plane. For measuring the intensity of irradiation the spacial examination of the incident radiation is very important; therefore, a cosine-corrected field view function has been preset.

## Comparison of Photometric and Radiometric Variables

Every photometric variable corresponds to a radiometric variable and involves the

same interrelationships between them. The variables can be distinguished by

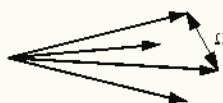
their index v (visual) and index e (energetic).

Lighting Engineering			Radiation Physics			
Variable	Symbol	Unit		Variable	Symbol	Unit
Light Flux	$\Phi_v$	lm=cd·sr		Radiation Capacity	$\Phi_e$	W
Luminous Intensity	$I_v$	cd		Radiant Intensity	$I_e$	W/sr
Luminance	$L_v$	cd/m		Radiancy	$L_e$	W/sr·m
Illuminance	$E_v$	lx=lm/m		Intensity of Irradiation	$E_e$	W/m
Light Quantity	$Q_v$	lm·s		Radiation Energy	$Q_e$	Ws
Lumination	$H_v$	lx·s		Radiation	$H_e$	Ws/m

## Spectral Valuation Function

The relative spectral sensitivity of the human eye is specified with different functions for the light-adapted eye (photopic vision) or for the dark-adapted eye (scotopic vision). Due to the individual differences this data can only be considered for average values but is sufficient for most technical purposes. The detailed data

of the spectral sensitivity curve are given in table format in the DIN 5031 standard. The two different spectral action functions result from the different „sensor types“ of the eye.

The relative luminous efficiency for photopic vision (rods,  $> 10\text{cd/m}^2$ ) is described with the function  $V(\lambda)$ , which is

the function used in most cases. The spectral luminous efficiency for the scotopic vision (cones,  $< 0.001\text{cd/m}^2$ ) is described with the function  $V'(\lambda)$  and can, with regard to the practical use, only be rarely found.

# Optical radiation

## Determination of Photometric Characteristic Factors

The metrological evaluation of the properties of materials regarding their reflection, transmission and absorption, as well as the stray light of objectives, is based on internationally accepted

recommendations. These mainly include the CIE 130-1998 „Practical methods for the measurements of reflectance and transmittance“, DIN 5036 Part 3 „Radiometric and photometric

characteristics of materials“, DIN 67507 „Light transmission factor of glazing“, DIN 58186 „Stray light determination of optically image-forming systems“.

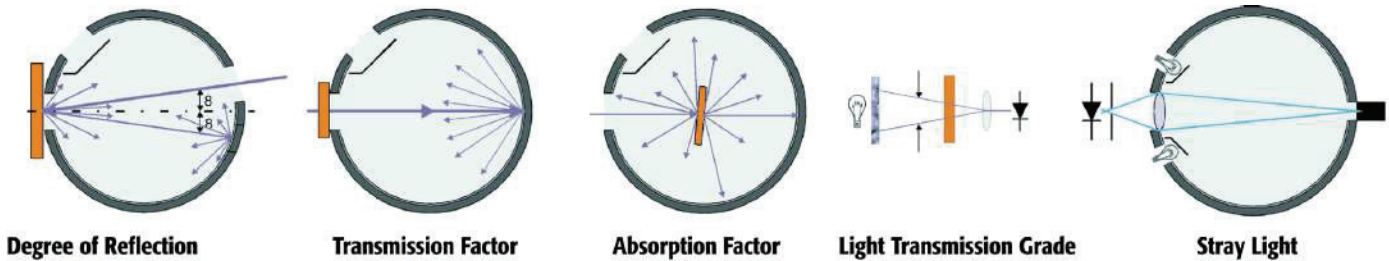

## Why Measure Optical Radiation?

A large part of the human sense impression is of an optical nature. Light is the only visible part of the electromagnetic spectrum. The human eye perceives different wave lengths of the light as colours. The spectral response of the eye, with regard to different colours, depends on the wave length. Furthermore, the human system is also influenced by ultraviolet radiation in a short-wave range and the infrared radiation in a long-wave range of the electromagnetic spectrum.

### Illumination:

People are used to daylight illumination. This can be approximately 5000 lux on a dull winter day, while on a sunny summer day approximately 100000 lux are reached. In contrast, only between 100 and 1000 lux are reached with artificial illumination. However, sufficient light is an essential factor for the well-being of people. Symptoms of tiredness, caused by insufficient light, do not generally occur at the eye but affect the whole body.

The standard DIN 5035/2, therefore, contains illumination standard values for health protection at work places.

These are legally bound in the guideline ASR 7/3 and it is imperative that this is observed.

The following nominal illuminations are valid for inside:

Offices:	office rooms	300 lux
	work places for writing and drawing	750 lux
Factories:	visual works within the production process	1000 lux
Hotels:	recreation rooms, reception, counter (cash)	200 lux
Shops:	front side of show windows	1500–2500 lux
Hospitals:	patients' rooms,	100–150 lux
	emergencies	500 lux
Schools:	lecture rooms, gymnasiums	300 Lux

### Global Radiation:

The global radiation is a measuring variable that is especially important for environmental research. It represents the entire diffuse and direct sun radiation that strikes the surface of the earth. The spectral range covers wavelengths from the short-wave range, at 300nm (UV-B), to the long-wave range, at 5000nm (IR).

### UVA Radiation:

The long-wave UV radiation (more than 313nm) reaches the surface of the earth

almost unfiltered and tans the human skin and strengthens the immune system. In solariums the biological effect of the UVA spectrum is used, combined with other spectral ranges, to trigger the direct pigmentation (melanin colouring). Damages to the connective tissue and premature skin ageing are promoted by too much radiation.

### UVB Radiation:

The short-wave UV range (less than 313nm) can cause irreversible damages.

All spectral characteristic functions that can have unfavourable effects on the human skin are summarised in the CIE recommendation. This recommendation is described in DIN 5050 and regarded as a guideline. A popular measure for the 'sunburn sensitivity' is, for example, the UV index 'UVI' provided by the German Weather Service. The measuring results provide, directly or in comparison with other spectral ranges, information that is of medical or biological relevance.

## Radiation probe FLA 623 x



- Probes for various spectral ranges:
- Illuminance ( $V_{\lambda}$ ), UVA, UVB, UVC, global radiation, IR, quantum (photosynthesis)
- Sturdy aluminum housing
- ALMEMO® connecting cable, plug-in
- For indoor applications

### Common technical data

Diffuser	PTFE	Electrical connection	Mountable male connector, lateral
Cosine correction	Error f2 <3 %	Connecting cable	PVC cable, plug-in, with ALMEMO® connector
Linearity	<1 %	Housing	Aluminum, black anodized
Absolute error	<10 % (<5 % for FLA623VL)	Fixture	2 screws M2 in base plate
$V_{\lambda}$ adapter	<3 % (for FLA623VL only)	Dimensions	Diameter 33 mm, height approx. 29 mm
Nominal temperature	22 °C ±2 K	Weight	approx. 50 g (without cable)
Operating temperature	-20 to +60 °C		
Signal output	0 to +2 V		
Duty cycle	<1 second		
Power supply	via ALMEMO® connector (5 to 15 VDC)		

## Probe for measuring illuminance FLA 623 VL

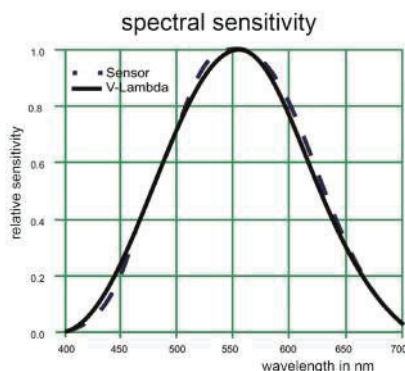

- This measures the  $V_{\lambda}$  radiation (visible light, equivalent to sensitivity of the human eye).
- For evaluating lighting conditions, e.g. in the workplace
- The sensor complies with device class B as per DIN 5032.

### Technical data:

Measuring range $V_{\lambda}$	0.05 to approx. 170 klx
Measuring channels	1st channel up to approx. 20,000 lx 2nd channel up to approx. 170.00 klx
Spectral sensitivity	380 to 720 nm, max. at 555 nm

Common technical data and image see page 14.05

### Variants (including factory test certificate)

Illuminance probe with ALMEMO® connecting cable, length = 2 meters

### Options

ALMEMO® connecting cable, length = 5 meters

ALMEMO® connecting cable, length = 10 meters

### Order no.

FLA623VL

OA9623L05

OA9623L10

# Optical radiation

## Probe for UVA radiation FLA 623 UVA

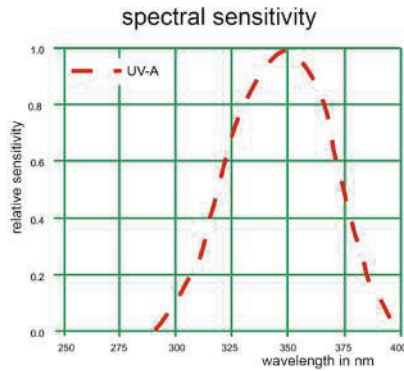

- This measures long-wave UV radiation (bronzing effect on human skin).
- Its spectral sensitivity is weighted towards global solar radiation.

### Technical data:

Measuring range	0.02 to approx. 50 W/m <sup>2</sup>
Spectral sensitivity	310 to 400 nm, maximum at 335 nm

Common technical data and image see page 14.05

### Variants (including factory test certificate)

UVA probe with ALMEMO® connecting cable, length = 2 meters

#### Options:

ALMEMO® connecting cable, length = 5 meters

ALMEMO® connecting cable, length = 10 meters

### Order no.

FLA623UVA

OA9623L05

OA9623L10

## Probe for UVB radiation FLA 623 UVB

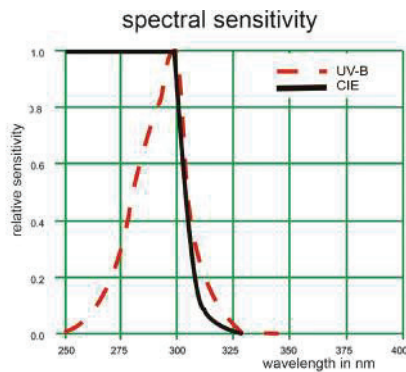

- This measures short-wave UVB radiation.
- Its spectral sensitivity is weighted towards global solar radiation likely to cause erythema (sunburn) as per CIE recommendation (Commission Internationale de l'Eclairage). The UV index can be calculated.

### Technical data:

Measuring range	0.002 to approx. 5 W/m <sup>2</sup>
Spectral sensitivity	265 to 315 nm, maximum at 297 nm

Common technical data and image see page 14.05

### Variants (including factory test certificate)

UVB probe with ALMEMO® connecting cable, length = 2 meters

#### Options

ALMEMO® connecting cable, length = 5 meters

ALMEMO® connecting cable, length = 10 meters

### Order no.

FLA623UVB

OA9623L05

OA9623L10

## Probe for UVC radiation FLA 623 UVC

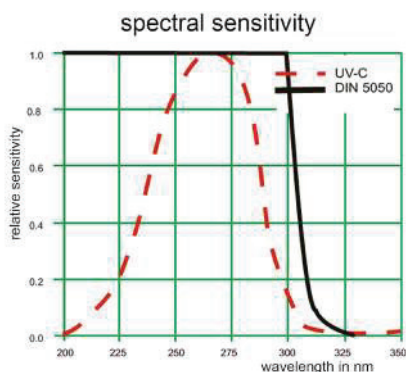

- This measures UVC radiation, e.g. Hg line at 256 nm.
- This probe can be used inter alia in water disinfection units.

### Technical data:

Measuring range	1 to approx. 1990 mW/m <sup>2</sup>
Spectral sensitivity	220 to 280 nm, maximum at 265 nm

Common technical data and image see page 14.05

### Variants (including factory test certificate)

UVC probe with ALMEMO® connecting cable, length = 2 meters

#### Options:

ALMEMO® connecting cable, length = 5 meters

ALMEMO® connecting cable, length = 10 meters

### Order no.

FLA623UVC

OA9623L05

OA9623L10

## Probe for global radiation FLA 623 GS

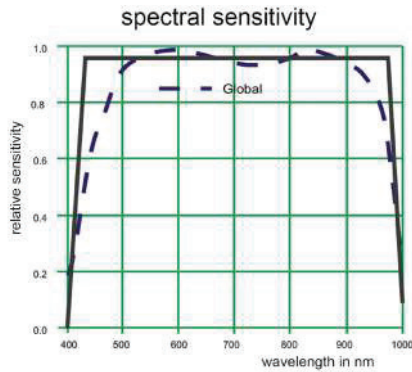

- This measures the solar spectrum in the visible range and in the short-wave IR range.
- Global radiation comprises both direct and diffused solar radiation.

### Technical data:

Measuring range	0.4 to approx. 1300 W/m <sup>2</sup>
Spectral sensitivity	400 to 1100 nm, maximum at 780 nm

Common technical data and image see page 14.05

### Variants (including factory test certificate)

Global radiation probe with ALMEMO® connecting cable, length = 2 meters

#### Options:

- ALMEMO® connecting cable, length = 5 meters
- ALMEMO® connecting cable, length = 10 meters

### Order no.

FLA623GS

OA9623L05

OA9623L10

## Probe for infra-red radiation FLA 623 IR

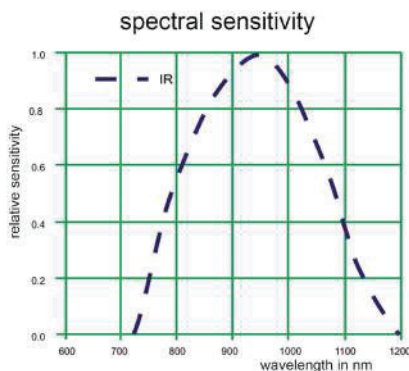

- This measures the solar spectrum in the short-wave IR range (excluding the visible range).

### Technical data:

Measuring range	0.1 to approx. 400 W/m <sup>2</sup>
Spectral sensitivity	800 to 1100 nm, maximum at 950 nm

Common technical data and image see page 14.05

### Variants (including factory test certificate)

IR probe with ALMEMO® connecting cable, length = 2 meters

#### Options:

- ALMEMO® connecting cable, length = 5 meters
- ALMEMO® connecting cable, length = 10 meters

### Order no.

FLA623IR

OA9623L05

OA9623L10

## Probe for quantum radiation FLA 623 PS

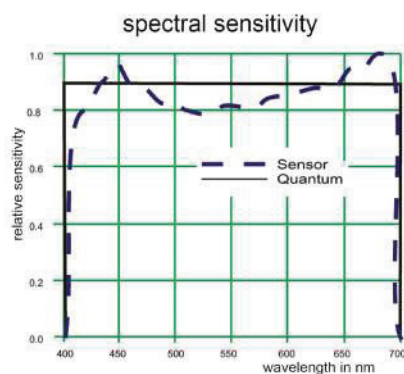

- This measures the visible light absorbed by the chlorophyll in plants during photosynthesis.
- It determines the level of quantum radiation in the spectral range specified.
- It is used to assess the conditions in which plants develop in open field and greenhouse cultivation.

### Technical data:

Measuring range	1 to approx. 3000 μmol/m <sup>2</sup> s
Spectral sensitivity	380 to 720 nm, maximum at 420 and 700 nm

Common technical data and image see page 14.05

### Variants (including factory test certificate)

Quantum probe with ALMEMO® connecting cable, length = 2 meters

#### Options:

- ALMEMO® connecting cable, length = 5 meters
- ALMEMO® connecting cable, length = 10 meters

### Order no.

FLA623PS

OA9623L05

OA9623L10

# Optical radiation

## Illuminance measuring head FLA 613 VLK



- Measuring independent of direction - thanks to the probe head's spherical characteristics
- Weather-proof aluminum housing, with plastic globe
- Suitable for universal use, inter alia for measuring in photostability tests according to various international standards and ICH guidelines (International Conference on Harmonization)
- Spectral range of the probe head corresponds to the sensitivity of the human eye (V-lambda radiation).

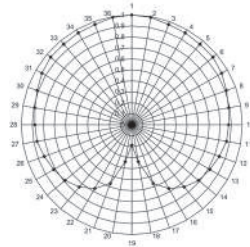
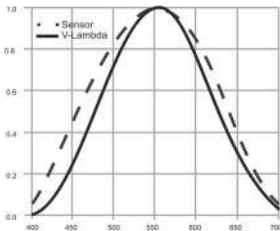

### Technical data:

Measuring range	0 to 50 klux
Spectral sensitivity	360 to 760 nm
Maximum spectral sensitivity	555 nm
Signal output	0 to 2 V
Duty cycle	<1 second
Power supply	via ALMEMO® connector +5 to +15 V
Fastening	2 screws, M4, in base plate
Cable passage	at side
Housing	anodized aluminum
Diffuser	Plastic
Ball	Plastic
Directional characteristic	see diagram
Linearity	<1%
Absolute error	<10%
Nominal temperature	22 ± 2 °C
Operating temperature	-20 to +60 °C
Dimensions	Ball diameter : 40 mm Overall height : 76 mm
Weight	approx. 100 grams

### Type (including test protocol)

Lux probe head for measuring illuminance, with spherical characteristic, including 1.5-meter cable and ALMEMO® connector

### Order no.

**FLA613VLK**

## UVA probe head FLA 613 UVAK



- Measuring independent of direction - thanks to the probe head's spherical characteristics
- Weather-proof aluminum housing, with plastic globe
- Suitable for universal use, inter alia for measuring in photostability tests according to various international standards and ICH guidelines (International Conference on Harmonization)
- Measuring head for measuring the UVA

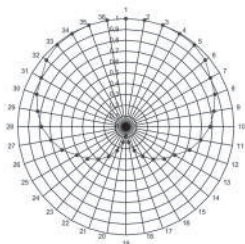
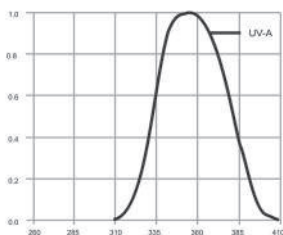

### Technical data:

Measuring range	0 to approx. 50 W/m <sup>2</sup>
Spectral sensitivity	310 to 400 nm
Maximum spectral sensitivity	355 nm
Signal output	0 to 2 V
Duty cycle	<1 second
Power supply	via ALMEMO® connector +5 to +15 V
Fastening	2 screws M4, in base plate
Cable passage	at side
Housing	anodized aluminum
Diffuser	PMMA (polymethyl methacrylate, acrylic)
Ball	PMMA (transparent to UV)
Directional characteristic	see diagram
Linearity	< 1%
Absolute error	< 10%
Nominal temperature	22 ± 2 °C
Operating temperature	-20 to +60 °C
Dimensions	Ball diameter : 40 mm Overall height: 76 mm
Weight	approx. 100 grams

### Type (including test protocol)

UVA probe head, with spherical characteristic, including 1.5-meter cable and ALMEMO® connector

### Order no.

**FLA613UVAK**

Factory calibration KL90xx radiation for sensor (see chapter Calibration certificates)



## Digital measuring head for illuminance (V-Lambda) FLAD 03-VL1 with ALMEMO® D6 connector

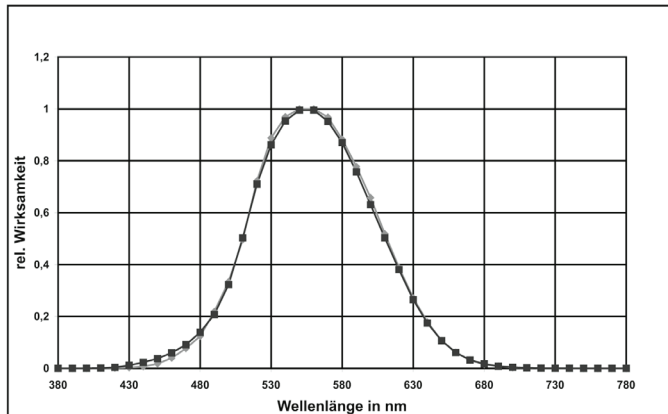

### V-lambda radiation

The spectral range of the visible light is referred to as V-lambda radiation and corresponds to the sensitivity of the human eye. The measured value is a measure for the perceived brightness. The wavelength range extends from the end of the UV spectrum at 400 nm to the beginning of the IR range at 720 nm with a maximum at 555 nm. The determined illuminance in "LUX" can directly be converted into the irradiance "W/ m<sup>2</sup>". Measurements in this particular range have a great importance for the workplace design and lighting projects.

### V-lambda radiation sensor FLAD 03 VL1

V-lambda sensors are used in the field of medical and/or biological research, for weather information and forecasting systems, for climate research, for agriculture, and for the automobile industry respectively for measuring artificial lighting. The spectral sensitivity of the receiver is extremely well adapted to the sensitivity of the human eye and complies with the device class B as per DIN 5032. The measuring head FLAD 03 VL1 has a black, anodized aluminum housing. The measurement is cos corrected. The measuring head is only suitable for indoor usage.

Digital measuring head with ALMEMO® D6 connector

The measuring head works with its own AD converter. Used extension cables and the measuring device have no influence on the accuracy of the measurement.

The entire measuring range is divided into 4 measuring ranges, so that, among other things, the smallest illuminances can be measured with a very high resolution.

### Technical data

Measuring range V-lambda	1 lx to 200 klx
ALMEMO® measuring ranges	
up to 650.00 lx	
up to 6500.0 lx	
up to 65000 lx	
up to 200.00 klx	
Minimum resolution	0.02 lx
Sensor system	Si / interf. filter
Spectral sensitivity	380 nm to 720 nm
Maximum spectral sensitivity	555 nm
Diffuser	PTFE
V-Lambda adaption	<3%
Cos-correction	error f2 < 2.0%
Linearity	< 1 %
Absolute error	< 5 %
Nominal temperature	23 °C ±3 K
Operating temperature	-20°C to +60°C
Switch-on time (Duty cycle)	< 1 s
Switch-off time	< 1 s
Dimensions	diameter 33 mm, height approx. 29 mm
Mounting	2 screws M3
Weight	approx. 50 g
ALMEMO® connection cable permanently connected cable 1.5 m with ALMEMO® D6 connector	
ALMEMO® D6 connector	
Refreshrate	1.5 s for all channels
Stabilization time	3 s (For data logger operation in sleep mode, a sleep delay of 3 s must be programmed)
Supply voltage	up to 6 V from the ALMEMO® device
Current consumption	approx. 4 mA

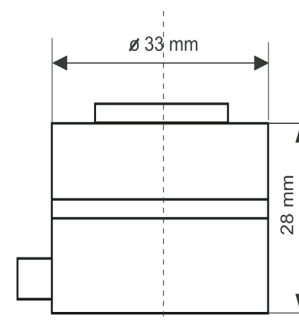

### Variants (incl. works test certificate)

Digital measuring head for illuminance, fixed cable, length 1.5 m, with ALMEMO® D6 connector

### Order no.

FLAD03VL1

## Digital sensor for color temperature and illuminance FLAD23CCT with ALMEMO® D6 plug



- Color temperature and illuminance are determined as a means to plot and evaluate lighting systems.
- Compact sensor, particularly suitable for mobile applications
- Continuous measuring and updating of measured values
- Digital color temperature sensor with „TrueColorSensorchip“ and integrated signal processor. The TrueColorSensorchip (3 sensors on 1 chip) detects - separately - each of the three colors - red, green, blue (RGB). The respective sensitivities of these 3 color sensors are adapted to the standard spectral curves as per CIE and DIN. (see Figure) On the basis of these RGB values the computer calculates the color point within the RGB range in terms of coordinates X and Y and determines the correlated color temperature (CCT) in Kelvin.
- The display shows simultaneously both this color data and the illuminance in lux (lx) or kilolux (klx).
- Freely selectable measurable variables  
Two measuring channels are programmed (at our factory): Color temperature (CCT, K), Illuminance (Ev, lx)  
Other measurable variable can also be selected: Illuminance (Ev, klx), X-value, Y-value  
The configuration is performed on the ALMEMO® V7 measuring instrument or directly on the PC using the USB adapter cable ZA1919AKUV (see chapter “ALMEMO® Network technology”).

### Technical data:

Spectral sensitivity	380 to 720 nm
Sensor system	TrueColor, 3 sensors on 1 chip
Measuring ranges	
Correlated color temperature (CCT)	54 to 30,000 K (at 120 lx to 170 klx)
Accuracy	< 10% in range 1600 to 17000 K
Coordinates resolution (dx, dy)	< 0.005
Illuminance (V-lambda)	10 to 65,000 lx (factory setting) or 0.05 to 170.00 klx
Accuracy	< 10% in range 120 lx to 170 klx
Cosine correction	8 mm diffuser plate
Cosine error	< 3%
Measuring duration	< 3 seconds
Nominal conditions	23 °C ± 3 K, 0 to 90 % RH (non-condensing)
Operating temperature	-10 to +40 °C
Dimensions	Diameter 25 mm, length 134 mm
ALMEMO® connecting cable	Fixed cable, 1.5 meters, with ALMEMO® D6 plug
ALMEMO® D6 plug	
Refresh rate	1.5 seconds for all channels
Setting time	3 seconds (In order to run the data logger in sleep mode a wakeup delay of 3 seconds must be programmed.)
Supply voltage	6 to 13 VDC
Current consumption	approx.. 4 mA

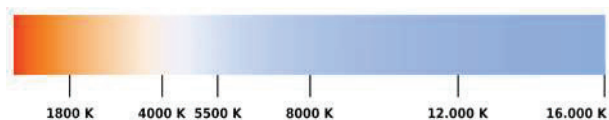

Color temperature sensor with ALMEMO® 2590-2 (example)

### Variants

Digital sensor for color temperature and illuminance, fitted cable, 1.5 meters with ALMEMO® D6 plug

### Order no.

FLAD23CCT

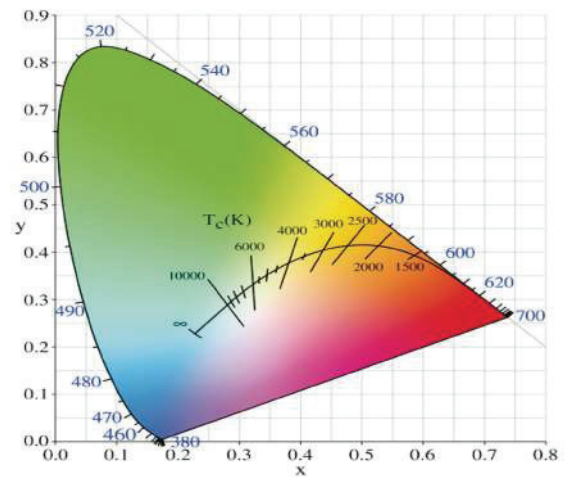
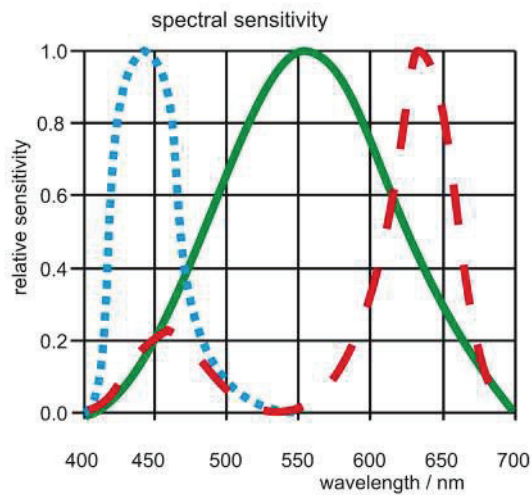

## Accessories

Ulbricht integrating sphere



- Ulbricht integrating sphere, for measuring total radiation from any light source
- Especially suitable for measuring operations on site for light sources that have already been installed. This minimizes interference from extraneous light in the environment.
- Dimensions
 

Measuring aperture	13.5 mm
Sphere diameter	40 mm
Housing diameter	44.5 mm, length 44 mm

## Accessories

An Ulbricht integrating sphere can be attached to color temperature sensor FLAD23CCT

Order no.

ZB9623KU

# Optical radiation

## Luminance Probe Head FLA 603 LDM2

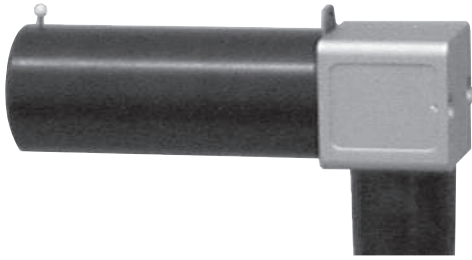

- Luminance measuring head, equipped with achromatically corrected, low stray light optics and high quality V(l) detector according to DIN class B.
- The external sighting device allows, at a working distance of 1m, to exactly locate the measuring point, therefore, it is particularly suitable for evaluating the luminance for service and constancy tests.
- Three measuring channels with different sensitivity.
- Typical applications: Luminescent surfaces such as colour monitors, alphanumeric displays, sign plates and light panels, and reflecting surfaces, such as walls and equipment at work places, projecting screens, traffic and sign plates, guided paths and roadway lines.

### Technical data:

Measuring range:	0.04 cd/m <sup>2</sup> to appr. 6400 cd/m <sup>2</sup>
Smallest resolution:	10 mcd/m <sup>2</sup>
Field of view:	1°
Sensitivity:	approx. 30 pA/(cd/m <sup>2</sup> )
Spectral adaptation:	approxim. to photometric valuat. function V(l) for photopic vision, class B, better than 6%
Field of view diameter :	approx. 30 mm at a distance of 0.5 m approx. 40 mm at a distance of 1 m approx. 120 mm at a distance of 5 m
Nominal temperature:	24°C ±2K
Operat./storage temperature:	0 to 60°C/-10 to +80°C
Humidity range:	10 to 90% (non-condensing)
Measuring surface:	21mm x 21mm at 1m operating distance
Meets standards:	IEC 61223-2-5, DIN 5032-T.7
Dimensions:	diameter 30mm, length 150 mm

### Variants

Luminance probe head with 1° field of view and external sighting device, DIN quality class B, with ALMEMO® connecting cable 1.5m long, incl. factory calibration certificate calibration in cd/m<sup>2</sup>

### Order no.

**FLA603LDM2**

## Light Flux Probe Head FLA 603 LSM4



- High quality measuring head, DIN class B for light flux measurement with Ulbricht globe photometer.
- Perfect coating of the globe with BaSO<sub>4</sub> for diffuse reflectivity and spectrally neutral reflection quality.
- Suitable for cold light sources, and lamps with high colour temperature and almost monochromatic radiation (as in LEDs).
- Examples for applications: Endoscopes, fiber optic bunches, light emitting diodes.

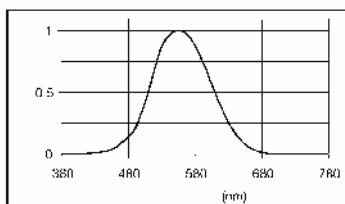

### Technical data:

Measuring range:	0.0002 lm to appr. 38 lm
Smallest resolution:	0.001 lm
Sensitivity:	20nA/lm
Acceptance angle:	up to 90°
Accuracy:	DIN quality class B
Nominal temperature:	24°C ±2K
Humidity range:	10 to 90 % non-condensing
Operating temperature:	max. 100°C inside globe
Inner diameter of globe:	50mm
Test opening:	12,7 mm

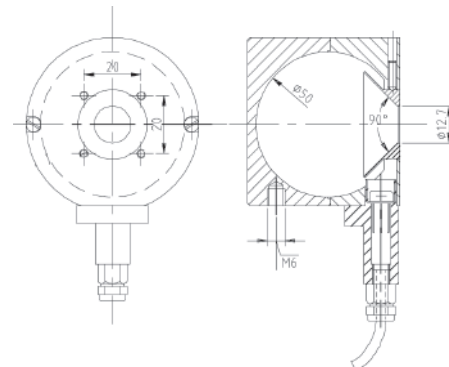

### Type

Light flux probe head with ALMEMO® connecting cable 2m long and factory calibration certificate

### Order no.

**FLA603LSM4**

Factory calibration KL90xx radiation for sensor (see chapter Calibration certificates)